

TRACEPAK



TRACEPAK®

*AN ENGINEERED,
PREINSULATED TUBING
BUNDLE SYSTEM FROM
O'BRIEN CORPORATION*

TRACEPAK solves the problems of:

- ▼ Freezing,
- ▼ Dew point Component drop-out,
- ▼ Viscosity,
- ▼ Personnel protection

Freezing, dew point, component drop-out and viscosity control are major considerations in instrument impulse connections, small diameter process lines and analyzer sample transport. A properly designed and selected pretraced tubing bundle offers an effective solution to these problems.

The economical choice to field fabrication

Maintenance free TRACEPAK not only saves money and time during the installation process, but it ensures consistent, repeatable performance. Field fabrication requires a pipe fitter to lay out, measure, cut, dress, bend and install the tubing. Next the tracer (steam or electric) has to be installed and insulation put on the tubing. Finally, a weatherproof covering needs to be applied over the insulation. Clearly the economics of the TRACEPAK system versus field fabrication are significant.

Provides predictable and repeatable performance

O'Brien Corporation, long recognized as the leader in providing reliable instrumentation protection, has simplified installation while offering predictable operation. TRACEPAK tube bundles are prefabricated, pre-engineered and preinsulated assemblies.

Installation is simplified by the unique parallel configuration, in which process and tracer lines are always parallel inside the bundle. The bundle is much easier to bend during field routing and hookup because all tubes bend together and not against one another.

Connections are easy because tubing stays round and is not work hardened

TRACEPAK's configuration allows the tubing to stay round and malleable when used in conjunction with compression and flare fittings. The installation of process and instrument connections requires only a simple, one-plane offset bend to engage tubing and fittings.

Can be installed at temperatures as low as -40°

O'Brien Corporation utilizes the highest quality materials. Our TPU jacket contains no halogens, eliminating the possibility of chlorides from the jacket causing stress corrosion in stainless steel tubing. This jacket has excellent abrasion and chemical resistance along with a wide, usable temperature range. TRACEPAK can be installed in temperatures as low as -40°.

Common types of pretraced lines:

- ▼ Electric traced lines, TPE, for freeze protection and maintenance of temperature.
- ▼ Steam traced lines, TPL & TPH, for freeze protection and temperature maintenance.
- ▼ Single preinsulated line, S-LINE, primarily for steam supply and condensate return.





Systems approach

With the advent of TRACEPAK, O'Brien Corporation has closed the loop in providing the entire instrument installation and protection needs for your plant. VPAK®, HEATPAK® and HEATPAK®II are enclosure systems that provide protection and steam or electric heat for the instrument and manifold. SADDLEPAK® is the perfect solution to the problems of mounting instrumentation. FLEXPAK® provides a custom, flexible cover for instrumentation.

The following pages will help you decide exactly which TRACEPAK product is right for your application.

Utilize TPS when insulation is required for personnel protection or when temperature loss needs to be minimized, but temperature maintenance is not necessary. Typical applications are steam supply, condensate return, water purge lines where flow is sufficient to prevent freezing, chemical additives, etc.

Use TPE, TPL or TPH when the process must be maintained within a specific temperature range or above a specific temperature.

Typical applications

Here are a few applications for the TRACEPAK System:

IMPULSE LINES

flow transmitters
pressure transmitters
level transmitters
pressure switches
controllers

SAMPLE LINES

analyzers
chromatographs

PROCESS LINES

steam supply
condensate return
water purge
chemical feed
air lines

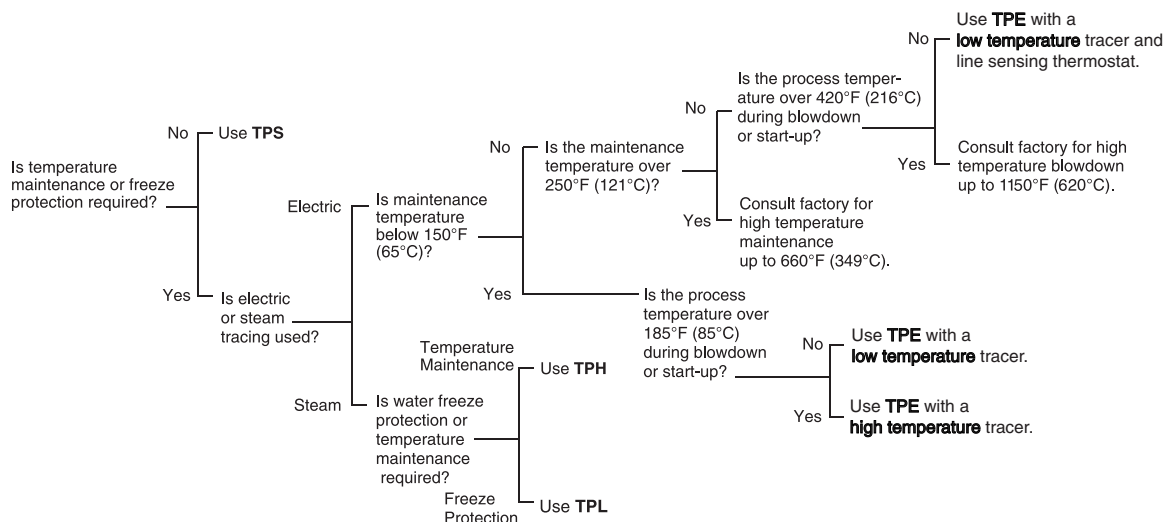

A preinsulated tubing bundle with self regulating electric tracing

TPE is designed to maintain freeze protection, close temperature tolerances or viscosity control.

It provides an excellent means of maintaining very long, continuous lengths of impulse lines and piping at consistent temperatures end-to-end. TPE should be chosen when electric tracing is preferred, steam is not available or when the steam supply could be interrupted such as during shutdowns.

Use TPE if the allowable temperature ranges from 50°F (10°C) to 250°F (121°C). Because it is self regulating, this system will lower its heat output as the process tube gets warmer. When close temperature control is necessary, TPE can be utilized with an optional line sensing thermostat.

Electric tracer

Standard TPE-Self Regulating products utilize two electric tracers approved for use in hazardous areas when installed with the recommended power connection kits.

The high temperature, Self Regulating Tracer:

1. Withstands 420°F (215°C) intermittent blowdown temperatures.
2. Can maintain temperatures up to 250°F (120°C).

The low temperature Self Regulating Tracer:

1. Withstands up to 185°F (85°C) blowdown temperatures.
2. Can maintain temperatures up to 150°F (65°C).

The choice between high and low temperature tracers must be made based on the desired performance and the conditions of the application.

Other designs are available to maintain temperatures up to 660°F (350°C) and withstand 1150°F (620°C) blowdown conditions. Consult factory for specific design.

Typical Performance

Each graph shows typical performance splitting summer/winter ambients. Each line is separated at 60°F (15°C) to designate the seasonal differences.

Winter ambients, below 60°F (15°C), assume a 25 mph (40 Km/H) wind and summer ambients, above 60°F (15°C), assume a 10 mph (16 Km/H) wind. For freeze protection, use 50°F (10°C) as the minimum allowable process tube temperature. This will provide a sufficient factor of safety.

Dimensions

	NOMINAL WT. LB/FT (KG/M)	NOMINAL DIMENSIONS - IN (CM)	
		A	B
TPE1- One 1/4" Process Tubes	0.3 (0.45)	1.1 (2.8)	1.0 (2.5)
TPE1- One 3/8" Process Tubes	0.4 (0.60)	1.3 (3.3)	1.0 (2.5)
TPE1- One 1/2" Process Tubes	0.5 (0.74)	1.4 (3.6)	1.1 (2.8)
TPE2- Two 1/4" Process Tubes	0.4 (0.60)	1.3 (3.3)	1.1 (2.8)
TPE2- Two 3/8" Process Tubes	0.6 (0.89)	1.5 (3.8)	1.2 (3.0)
TPE2- Two 1/2" Process Tubes	0.8 (1.19)	1.7 (4.3)	1.4 (3.6)

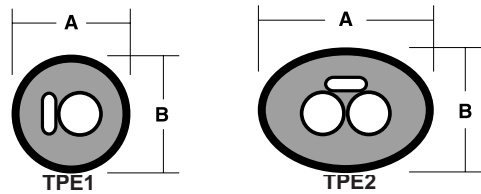

TPE1 - ONE 1/2" PROCESS LINE WITH LOW TEMPERATURE TRACER

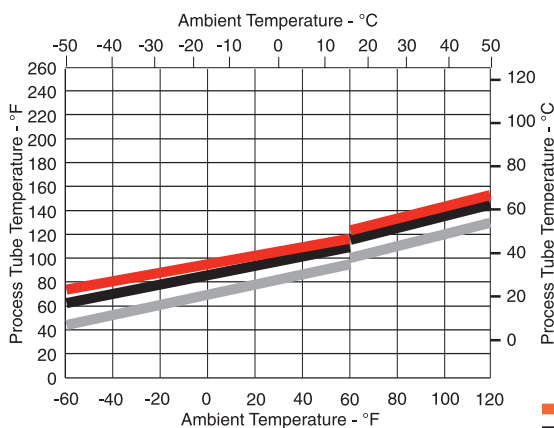

TPE2 - TWO 1/2" PROCESS LINES WITH LOW TEMPERATURE TRACER

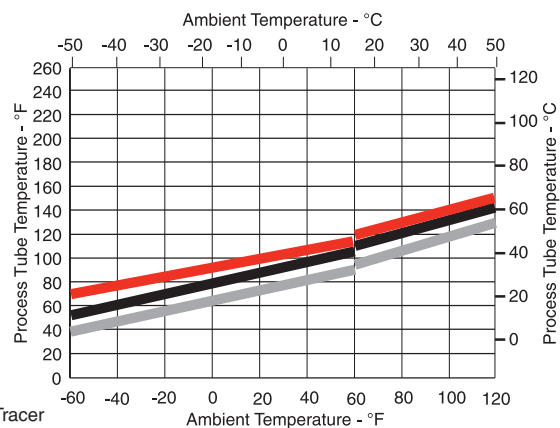

- J10 or P10 Tracer
- J8 or P8 Tracer
- J5 or P5 Tracer



Model Number

Product Family

TPE1- Preinsulated Electrically Traced Single Process Tube

TPE2- Preinsulated Electrically Traced Dual Process Tubes

Jacket

S - SV47

U - TPU

This is a condensed list of tube and tracer options. For a full product offering consult the Tube and Tracer Spec Sheet.

Process Tube

- A2** 1/4" x 0.035 wall welded 316SS
- A3** 3/8" x 0.035 wall welded 316SS
- A4** 1/2" x 0.035 wall welded 316SS
- E4** 1/2" x 0.049 wall welded 316SS
- F1** 1/8" x 0.035 wall seamless 316SS
- F2** 1/4" x 0.035 wall seamless 316SS
- F3** 3/8" x 0.035 wall seamless 316SS
- F4** 1/2" x 0.035 wall seamless 316SS
- B2** 1/4" x 0.049 wall seamless 316SS
- B3** 3/8" x 0.049 wall seamless 316SS
- B4** 1/2" x 0.049 wall seamless 316SS
- G2** 1/4" OD x 0.030 wall PFA Teflon®
- G3** 3/8" OD x 0.030 wall PFA Teflon
- H4** 1/2" OD x 0.062 wall PFA Teflon
- MF6** 12mm OD x 1mm wall seamless 316SS
- MF8** 12mm OD x 1mm wall seamless 316SS
- MF10** 12mm OD x 1mm wall seamless 316SS
- MF12** 12mm OD x 1mm wall seamless 316SS
- MB10** 10mm OD x 1.5mm wall seamless 316SS
- MB12** 12mm OD x 1.5mm wall seamless 316SS
- MG6** 6mm OD x 1mm wall PFA Teflon
- MG8** 8mm OD x 1mm wall PFA Teflon
- MG10** 10mm OD x 1mm wall PFA Teflon
- MG12** 12mm OD x 1mm wall PFA Teflon
- MA12** - 12mm OD x 1mm wall welded 316SS

Tracer

High Temperature Tracer

- B5-** 5w/ft (16w/m) self-regulating heater @ 50°F (10°C), 120 vac
- B10-** 10w/ft (29w/m) self-regulating heater @ 50°F (10°C), 120 vac
- B15-** 15w/ft (47w/m) self-regulating heater @ 50°F (10°C), 120 vac
- B20-** 20w/ft (63w/m) self-regulating heater @ 50°F (10°C), 120 vac
- N5-** 5w/ft (16w/m) self-regulating heater @ 50°F (10°C), 240 vac
- N10-** 10w/ft (29w/m) self-regulating heater @ 50°F (10°C), 240 vac
- N15-** 15w/ft (47w/m) self-regulating heater @ 50°F (10°C), 240 vac
- N20-** 20w/ft (63w/m) self-regulating heater @ 50°F (10°C), 240 vac

Low Temperature Tracer

- J5-** 5w/ft (16w/m) self-regulating heater @ 50°F (10°C), 120 vac
- J8-** 8w/ft (25w/m) self-regulating heater @ 50°F (10°C), 120 vac
- J10-** 10w/ft (29w/m) self-regulating heater @ 50°F (10°C), 120 vac
- P5-** 5w/ft (16w/m) self-regulating heater @ 50°F (10°C), 240 vac
- P8-** 8w/ft (25w/m) self-regulating heater @ 50°F (10°C), 240vac
- P10-** 10w/ft (29w/m) self-regulating heater @ 10°C, 240vac

Specialty Tracers

- JV10-** 10w/ft (29w/m) self-regulating heater @ 50°F (10°C), 120 vac
- JV20-** 20w/ft (63w/m) self-regulating heater @ 50°F (10°C), 240 vac
- JN10-** 10w/ft (29w/m) self-regulating heater @ 50°F (10°C), 10 vac
- JN20-** 20w/ft (63w/m) self-regulating heater @ 50°F (10°C), 240 vac

Standard tracers have a tinned copper shield and fluoropolymer outer jacket. They are approved to ATEX, CSA, and NEC standards for use in hazardous areas. Most configurations are rated for T3 or lower maximum temperatures. Consult factory for specific approvals.

Example:

TPE2S-A4-B5

Two 1/2" x 0.035 wall 316SS welded process lines with an SV47 jacket and a 5w/ft (16w/m) tracer.

For specific information regarding each of these products, consult TRACEPAK SPECIFICATIONS.

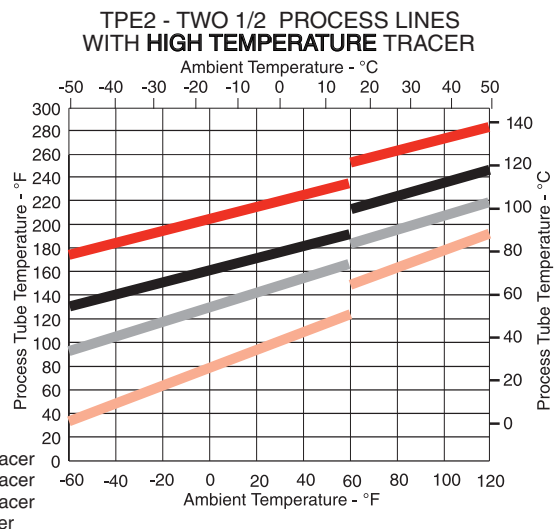
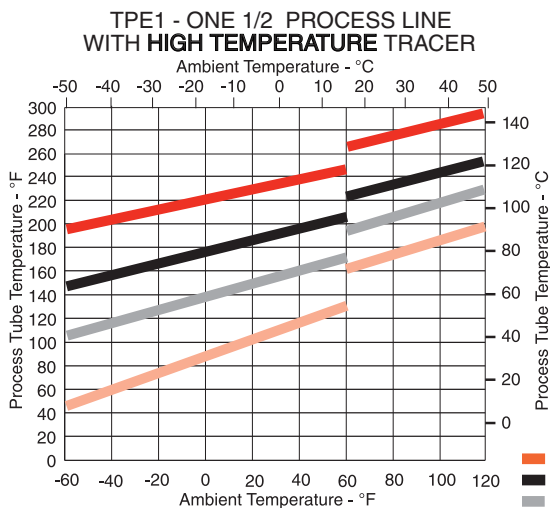

A preinsulated tubing bundle with light steam tracing



The tracer tube is wrapped with insulation to purposely reduce heat transfer.

TPL can maintain temperatures between 50°F (10°C) and 200°F (95°C). It provides a more constant tube temperature over a longer length than heavy traced designs.

It is suited for small diameter process lines such as those used for sampling and additives.

TPL is recommended for freeze protection of instrument impulse lines as well as the process lines for analyzers.

Model Number

Product Family

TPL1-Preinsulated Light Steam Traced

Single Process Tube

TPL2-Preinsulated Light Steam Traced

Dual Process Tubes

Jacket

S - SV47

U - TPU

This is a condensed list of tube and tracer options. For a full product offering consult the Tube and Tracer Spec Sheet.

Process Tube

- A2** 1/4" x 0.035 wall welded 316SS
- A3** 3/8" x 0.035 wall welded 316SS
- A4** 1/2" x 0.035 wall welded 316SS
- E4** 1/2" x 0.049 wall welded 316SS
- F1** 1/8" x 0.035 wall seamless 316SS
- F2** 1/4" x 0.035 wall seamless 316SS
- F3** 3/8" x 0.035 wall seamless 316SS
- F4** 1/2" x 0.035 wall seamless 316SS
- B2** 1/4" x 0.049 wall seamless 316SS
- B3** 3/8" x 0.049 wall seamless 316SS
- B4** 1/2" x 0.049 wall seamless 316SS
- B6** 3/4" x 0.049 wall seamless 316SS
- K4** 1/2" x 0.065 wall seamless 316SS
- G2** 1/4" OD x 0.030 wall PFA Teflon®
- G3** 3/8" OD x 0.030 wall PFA Teflon
- H3** 3/8" OD x 0.062 wall PFA Teflon
- H4** 1/2" OD x 0.062 wall PFA Teflon
- S2** 1/4" OD x 0.040 wall PFA Teflon
- MF6** 12mm OD x 1mm wall seamless 316SS
- MF8** 12mm OD x 1mm wall seamless 316SS
- MF10** 12mm OD x 1mm wall seamless 316SS
- MF12** 12mm OD x 1mm wall seamless 316SS
- MB10** 10mm OD x 1.5mm wall seamless 316SS
- MB12** 12mm OD x 1.5mm wall seamless 316SS

- MG6** 6mm OD x 1mm wall PFA Teflon
- MG8** 8mm OD x 1mm wall PFA Teflon
- MG10** 10mm OD x 1mm wall PFA Teflon
- MG12** 12mm OD x 1mm wall PFA Teflon
- MA12** - 12mm OD x 1mm wall welded 316SS

Tracer

- A2** 1/4" x 0.035 wall welded 316SS
- A3** 3/8" x 0.035 wall welded 316SS
- A4** 1/2" x 0.035 wall welded 316SS
- F2** 1/4" x 0.035 wall seamless 316SS
- F3** 3/8" x 0.035 wall seamless 316SS
- B4** 1/2" x 0.049 wall seamless 316SS
- J2** 1/4" x 0.030 wall copper
- C3** 3/8" x 0.032 wall copper
- M4** 1/2" x 0.049 wall copper
- N2** 1/4" OD x 0.035 wall seamless Monel 400
- N3** 3/8" OD x 0.035 wall seamless Monel 400
- P4** 1/2" OD x 0.049 wall seamless Monel 400
- MF6** 5mm OD x 1.5mm wall seamless 316SS
- MF8** 8mm OD x 1.5mm wall seamless 316SS
- MF10** 10mm OD x 1.5mm wall seamless 316SS
- MF12** 12mm OD x 1.5mm wall seamless 316SS
- MD6** 6mm OD x 1mm wall copper
- MD8** 8mm OD x 1mm wall copper
- MD10** 10mm OD x 1mm wall copper
- MD12** 12mm OD x 1mm wall copper

Example:

TPL2S-A4-C3

Two 1/2" x 0.035 wall 316SS welded process lines with an SV47 jacket and 3/8" x 0.032 wall copper tracer.

For specific information regarding each of these products, consult TRACEPAK SPECIFICATIONS.

Dimensions

	NOMINAL WT. LB/FT (KG/M)	NOMINAL DIMENSIONS - IN (CM)	
		A	B
TPL1- One 3/8" Process with 3/8" Tracer	0.63 (0.94)	2.0 (5.1)	1.6 (4.1)
TPL1- One 1/2" Process with 3/8" Tracer	0.81 (1.21)	2.2 (5.6)	1.7 (4.3)
TPL1- One 1/2" Process with 1/2" Tracer	0.85 (1.26)	2.2 (5.6)	1.7 (4.3)
TPL2- Two 3/8" Process with 3/8" Tracer	0.87 (1.26)	2.3 (5.8)	1.6 (4.1)
TPL2- Two 1/2" Process with 3/8" Tracer	1.09 (1.62)	2.7 (6.9)	1.7 (4.3)
TPL2- Two 1/2" Process with 1/2" Tracer	1.13 (1.68)	2.7 (6.9)	1.7 (4.3)

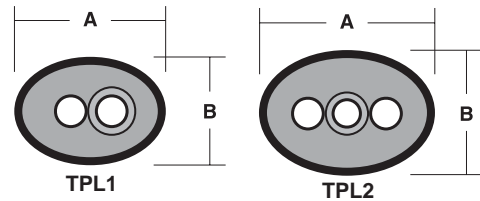

TWO 1/2" PROCESS LINES WITH ONE 1/2" TRACER TYPICAL PERFORMANCE

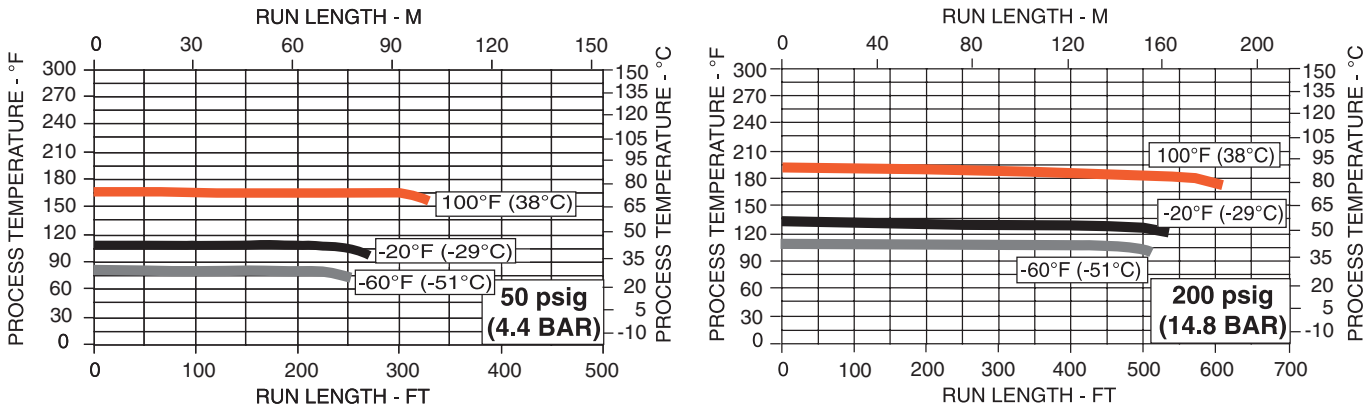

A preinsulated tubing bundle with heavy steam tracing

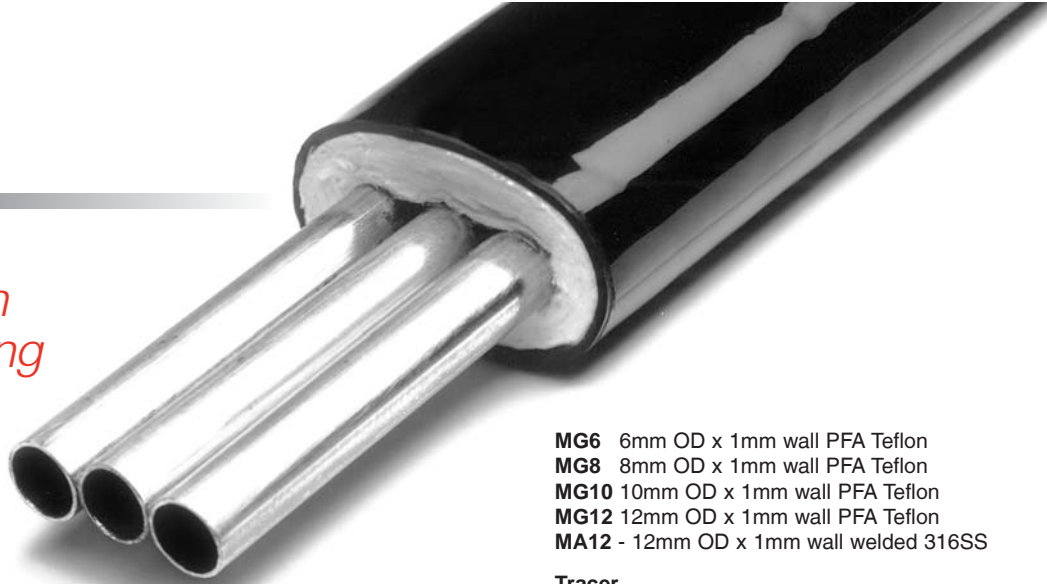

Heavy tracing keeps the process tubing in direct contact with the tracer and maintains higher process temperatures.

TPH is recommended for use on analyzer sample transport and instrumentation impulse lines. It is also recommended for additives and other small diameter process lines where higher temperature maintenance or viscosity control is necessary.

Model Number

Product Family

TPH1-Preinsulated Heavy Steam Traced Single Process Tube

TPH2-Preinsulated Heavy Steam Traced Dual Process Tubes

Jacket

S - SV47

U - TPU

This is a condensed list of tube and tracer options. For a full product offering consult the Tube and Tracer Spec Sheet.

Process Tube

- A2** 1/4" x 0.035 wall welded 316SS
- A3** 3/8" x 0.035 wall welded 316SS
- A4** 1/2" x 0.035 wall welded 316SS
- E4** 1/2" x 0.049 wall welded 316SS
- F1** 1/8" x 0.035 wall seamless 316SS
- F2** 1/4" x 0.035 wall seamless 316SS
- F3** 3/8" x 0.035 wall seamless 316SS
- F4** 1/2" x 0.035 wall seamless 316SS
- B2** 1/4" x 0.049 wall seamless 316SS
- B3** 3/8" x 0.049 wall seamless 316SS
- B4** 1/2" x 0.049 wall seamless 316SS
- B6** 3/4" x 0.049 wall seamless 316SS
- K4** 1/2" x 0.065 wall seamless 316SS
- G2** 1/4" OD x 0.030 wall PFA Teflon®
- G3** 3/8" OD x 0.030 wall PFA Teflon
- H3** 3/8" OD x 0.062 wall PFA Teflon
- H4** 1/2" OD x 0.062 wall PFA Teflon
- S2** 1/4" OD x 0.040 wall PFA Teflon
- MF6** 12mm OD x 1mm wall seamless 316SS
- MF8** 12mm OD x 1mm wall seamless 316SS
- MF10** 12mm OD x 1mm wall seamless 316SS
- MF12** 12mm OD x 1mm wall seamless 316SS
- MB10** 10mm OD x 1.5mm wall seamless 316SS
- MB12** 12mm OD x 1.5mm wall seamless 316SS

- MG6** 6mm OD x 1mm wall PFA Teflon
- MG8** 8mm OD x 1mm wall PFA Teflon
- MG10** 10mm OD x 1mm wall PFA Teflon
- MG12** 12mm OD x 1mm wall PFA Teflon
- MA12** - 12mm OD x 1mm wall welded 316SS

Tracer

- A2** 1/4" x 0.035 wall welded 316SS
- A3** 3/8" x 0.035 wall welded 316SS
- A4** 1/2" x 0.035 wall welded 316SS
- F2** 1/4" x 0.035 wall seamless 316SS
- F3** 3/8" x 0.035 wall seamless 316SS
- B4** 1/2" x 0.049 wall seamless 316SS
- J2** 1/4" x 0.030 wall copper
- C3** 3/8" x 0.032 wall copper
- M4** 1/2" x 0.049 wall copper
- N2** 1/4" OD x 0.035 wall seamless Monel 400
- N3** 3/8" OD x 0.035 wall seamless Monel 400
- P4** 1/2" OD x 0.049 wall seamless Monel 400
- MF6** 5mm OD x 1.5mm wall seamless 316SS
- MF8** 8mm OD x 1.5mm wall seamless 316SS
- MF10** 10mm OD x 1.5mm wall seamless 316SS
- MF12** 12mm OD x 1.5mm wall seamless 316SS
- MD6** 6mm OD x 1mm wall copper
- MD8** 8mm OD x 1mm wall copper
- MD10** 10mm OD x 1mm wall copper
- MD12** 12mm OD x 1mm wall copper

Example:

TPH2S-A4-C3

Two 1/2" x 0.035 wall 316SS welded process lines with an SV47 jacket and 3/8" x 0.032 wall copper tracer.

For specific information regarding each of these products, consult TRACEPAK SPECIFICATIONS.

Dimensions

	NOMINAL WT. LB/FT (KG/M)	NOMINAL DIMENSIONS - IN (CM)	
		A	B
TPH1- One 3/8" Process with 3/8" Tracer	0.5 (0.74)	1.5 (3.8)	1.2 (3.0)
TPH1- One 1/2" Process with 3/8" Tracer	0.6 (0.89)	1.6 (4.1)	1.2 (3.0)
TPH1- One 1/2" Process with 1/2" Tracer	0.7 (1.04)	1.7 (4.3)	1.2 (3.0)
TPH2- Two 3/8" Process with 3/8" Tracer	0.6 (0.89)	2.0 (5.1)	1.2 (3.0)
TPH2- Two 1/2" Process with 3/8" Tracer	0.7 (1.04)	2.1 (5.4)	1.2 (3.0)
TPH2- Two 1/2" Process with 1/2" Tracer	0.8 (1.19)	2.2 (5.6)	1.2 (3.0)

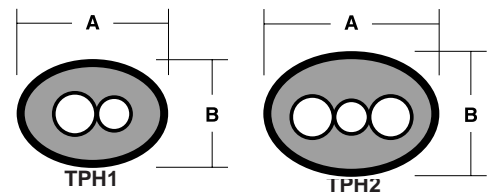

TWO 1/2" PROCESS LINES WITH ONE 3/8" TRACER TYPICAL PERFORMANCE

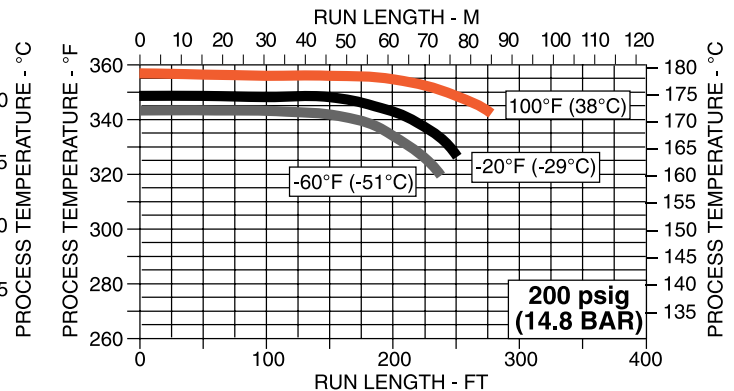
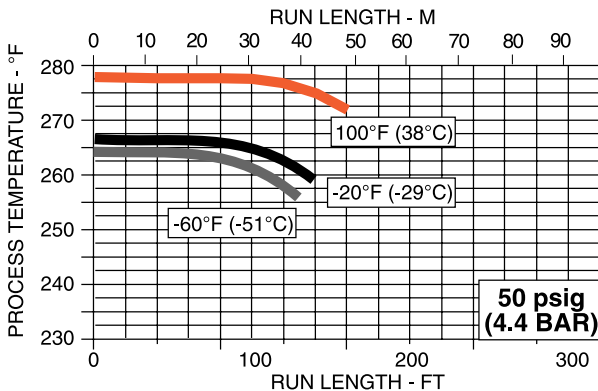

S-LINE & J-LINE

S-LINE: A weather-proofed, preinsulated single tubing line

S-LINE is designed specifically for liquid and gas transport lines where heat loss and personnel protection are important. S-LINE offers an inexpensive alternative to field insulation and weatherproofing of small lines.

Model Number

Product Family

S-Preinsulated Single Process Tube with an SV47 Jacket

J-Single Process Tube with an SV47 Jacket

J-LINE: A weather-proofed, single tubing line

J-Line tubing is designed for pneumatic and hydraulic applications in corrosive atmospheres. Industry standard tubing coated with O'Brien SV47 polymer provides increased protection against galvanic and atmospheric corrosion as well as cushioning the tube against wear from vibration.

Process Tube

A2 1/4" x 0.035 wall welded 316SS

A3 3/8" x 0.035 wall welded 316SS

A4 1/2" x 0.035 wall welded 316SS

E4 1/2" x 0.049 wall welded 316SS

F1 1/8" x 0.035 wall seamless 316SS

F2 1/4" x 0.035 wall seamless 316SS

F3 3/8" x 0.035 wall seamless 316SS

F4 1/2" x 0.035 wall seamless 316SS

B2 1/4" x 0.049 wall seamless 316SS

B3 3/8" x 0.049 wall seamless 316SS

B4 1/2" x 0.049 wall seamless 316SS

J2 1/4" x 0.030 wall copper

C3 3/8" x 0.032 wall copper

D4 1/2" x 0.035 wall copper

M4 1/2" x 0.049 wall copper

M6 3/4" x 0.049 wall copper

MF6 12mm OD x 1mm wall seamless 316SS

MF8 12mm OD x 1mm wall seamless 316SS

MF10 12mm OD x 1mm wall seamless 316SS

MF12 12mm OD x 1mm wall seamless 316SS

MB10 10mm OD x 1.5mm wall seamless 316SS

MB12 12mm OD x 1.5mm wall seamless 316SS

Examples:

SC3

One preinsulated 3/8" x 0.032 wall copper process line with an SV47 jacket.

JC3

One 3/8" x 0.032 wall copper process line with an SV47 jacket.

For specific information regarding each of these products, consult TRACEPAK SPECIFICATIONS.

Dimensions

	NOMINAL WT. LB/FT (KG/M)	NOMINAL DIMENSIONS A - IN (CM)
S-LINE- One 1/4" Process Line	0.2 (0.30)	1.0 (2.5)
S-LINE- One 3/8" Process Line	0.3 (0.45)	1.1 (2.8)
S-LINE- One 1/2" Process Line	0.4 (0.60)	1.2 (3.0)

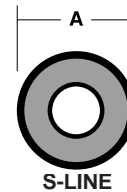

3/8" TUBE

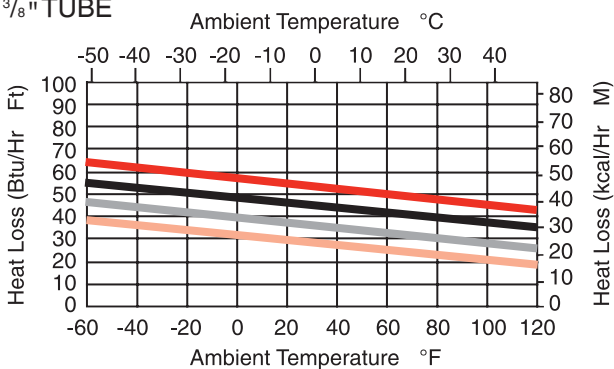

1/2" TUBE

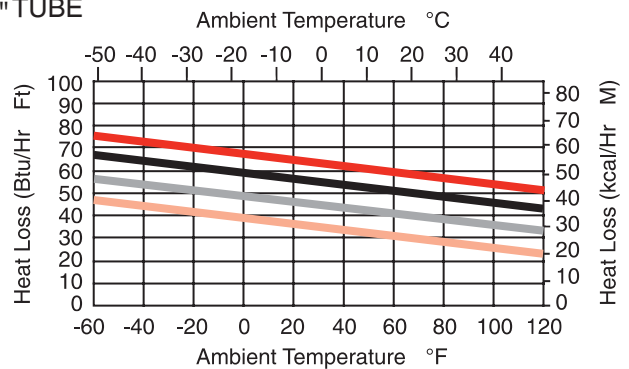

- 200 psig (15 BAR) steam
- 125 psig (9.5 BAR) steam 353°F
- 50 psig (4.5 BAR) steam 299°F
- 15 psig (2.0 BAR) steam 250°F

ADDITIONAL CAPABILITIES

Stackpak, Heated Hose and Custom Designs Solutions for unique applications



In addition to conventional TRACEPAK designs, O'Brien can satisfy your special needs with custom solutions. These designs are verified in our environmental chamber under conditions that insure a tubing bundle that meets your exact requirements, with reliability and accuracy you can depend on.

Custom Capabilities

- Indoor & Outdoor Jackets
- Maintenance Temperatures to 660°F (350°C)
- Custom Lengths
- Choice of Process Connection Fittings
- Pre-terminated and Fitted Ends
- Factory Installed Temperature Sensors
- Communication, Monitor and Power Wires
- Alternate Jacket Colors

Unusual Tube Material Nonstandard Sizes

TRACEPAK can be manufactured with a wide range of uncommon materials and sizes to conform to your unique material requirements, including:

- Teflon® variations such as PTFE, PFA, TFE, and nylon.
- Hastelloy
- Incoloy
- Titanium
- Duplex and Super Duplex
- 6% Moly
- Oxygen Cleaned Tubes
- Chemically Polished Stainless Steel with Silcosteel® Coating
- Electropolished Stainless Steel with Sulfinert® Coating

Multi-Component Bundles

Complex designs incorporate factory installed temperature sensors such as RTD's, PT100's thermocouples with multiple process tubes, calibration gas supply tubes, tracers, communication wires, power wiring, and heat tracing.

High Temperature Heaters

Specialty tracers such as CPD, MI and resistance wires can be used to provide temperature maintenance up to 660°F (350°C) and to withstand a high temperature blowdown of 1150°F (620°C).

Jacket Materials for Diverse Applications

Jacket materials are available to withstand high operating temperatures, permit installation at low ambients or stand up to constant flexing. Materials include polyurethane, polyethylene or PVC for outdoor applications, and polyethylene braid or stainless steel braid for indoor applications.

Performance Enhancing Designs

Special isolated or buffered designs are available for applications with high intermittent process temperatures. These designs isolate the standard self-limiting tracer from the process tube to allow higher maximum exposure temperatures while still providing freeze protection.

Typical Applications

Sampling Systems

Emissions Gas Sampling, Process and Portable Analyzers, Automotive Emissions Testing,

Viscosity Control

Petroleum products, Asphalt, Tar, Paint Systems, Printing Ink, Coatings, Spray Foam Insulation

Product Transfer

Polymers, Oil, Urethanes, Wax, Chemicals, Food Products, Fat or Freeze Protection, Hot Melt Adhesives, Sanitary Applications.

®Silcosteel and Sulfinert are registered trademarks of Restek Corporation.

ACCESSORIES

Sealing the bundle

Although TRACEPAK products use a non-hygroscopic, non-wicking insulation, all bundle ends must be sealed to prevent any possible moisture contamination.

TPKSK - Silicone Sealant

This option is used to seal both ends of the tubing bundle from moisture. It is a black silicone RTV sealant. Cure time is approximately 24 hours at 77°F (25°C). Service temperature ranges from -50°F (-45°C) to 400°F (205°C). TPKSK offers excellent resistance to weather, oil and many chemicals.

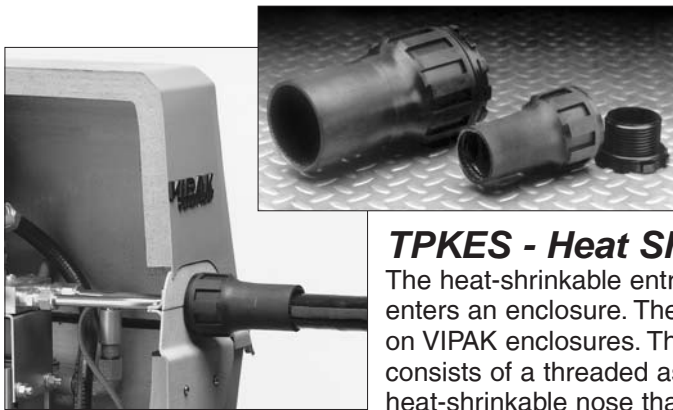

TPKES - Heat Shrink Entry Seal

The heat-shrinkable entry seal provides a waterproof fitting where TRACEPAK enters an enclosure. They can be added to parting line or surface mounted plates on VIPAK enclosures. The thermally stabilized, modified polyolefin entry seal consists of a threaded assembly that seals at the enclosure and a heat-shrinkable nose that seals to the TRACEPAK bundle.



TPKHS - Heat Shrink Boots

The heat-shrinkable boots provide a weatherproof end seal for TRACEPAK tubing bundles. They are made of thermally stabilized, modified polyolefin. Using a heat shrink end seal boot is recommended for all exposed ends. This installation will provide the best weather seal protection.

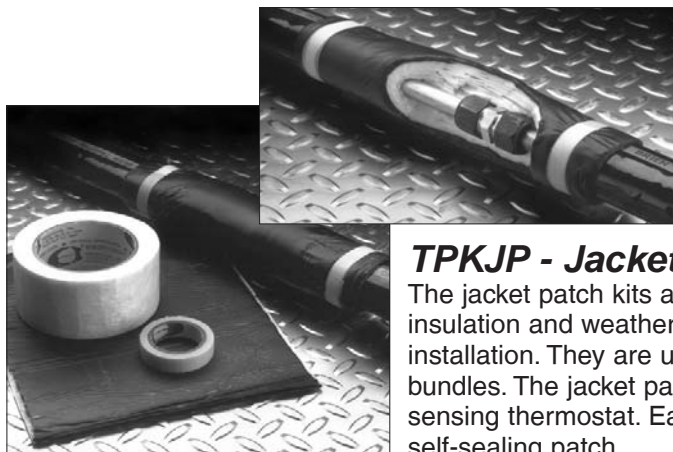

TPKJP - Jacket Patch

The jacket patch kits are used to seal a splice in a bundle or to extend the insulation and weatherproof jacket should the bundle be cut back too far during installation. They are used as a repair patch for any incidental field damage to bundles. The jacket patch kit is required with the optional line temperature sensing thermostat. Each kit contains thermal insulation, fiberglass tape and a self-sealing patch.

Temperature Control

SensorTube™

SensorTube creates a pathway for the RTD kit to be positioned up to 15' (3m) from the control end without any special tools. This eliminates cutting into the bundle with field installed RTDs. The specially sized bulb and lead construction of the kit can be easily inserted into the bundle even after it is installed. The RTD kit has been inserted through more than five ninety degree bends without problems.

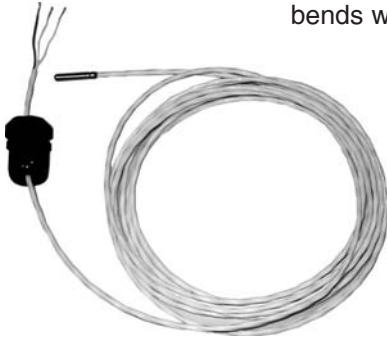

RTD Kit

RTD Kit includes a 100 Ohm / PT100, 3 wire sensor with twenty feet of fluoropolymer jacketed leads and an entry seal.

910 Series Controllers

The 910 Series controllers are compact, full featured, microprocessor based single and dual point heat trace controllers. They provide control and monitoring of Tracepak and Stackpak tubing bundles designed for freeze protection and temperature maintenance. The controllers can be set to monitor and alarm high and low temperature, high and low current, ground fault trip and voltage. The controllers are supplied with a solid-state relay (SSR) for use in nonhazardous and Class I Div. 2 / Zone 2 hazardous areas.



THERMOSTATS

When used with electrically traced tubing bundles, optional thermostats are used to control the temperature of the process tube or to turn on the heater circuit at a specified ambient temperature.



Ambient Sensing

The ambient sensing thermostat has an adjustable set point of 14°F to 140°F (-10°C to 60°C) and can withstand ambient temperatures of -40°F to 160°F (-40°C to 70°C). It has a fluid filled stainless steel probe and the SPDT switch is rated for 22A at 125/250/480 VAC. It is UL listed and CSA certified for use in hazardous areas.

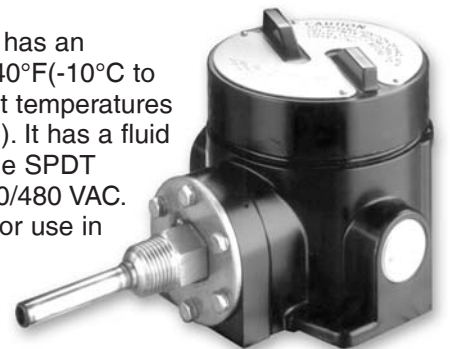

Line Sensing or Ambient Sensing

The line sensing thermostat controls the temperature of the process tubes. It has an adjustable set point of 25°F to 325°F (-5°C to 163°C) and can withstand process temperatures from -65°F to 500°F (-55°C to 260°C). The fluid filled stainless steel bulb has a 10' capillary. The SPDT switch is rated for 22A at 125/250/480 VAC. Model TPKTS-B-7 is UL and FM listed and CSA certified for use in hazardous areas. Model RAYSTAT-EX-02 is EEx d approved for use in hazardous areas.

Note:
Models shown are typical of thermostats supplied.
Units received may differ depending on approvals.

ACCESSORIES

Power Connection and End Termination Kits



T210-PC

FM Approved and CSA Certified Class I Div. 2 power connection kit for use with any wattage B, N, J, or P tracer. Includes junction box and bundle mounting bracket with adjustable straps. Junction box also includes surface mounting feet.

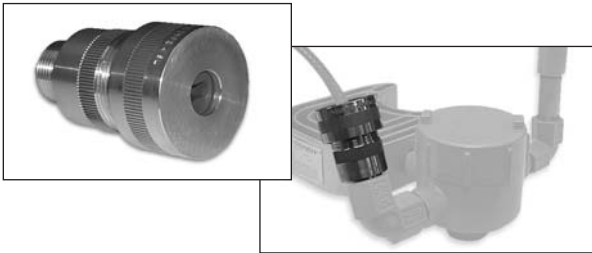

TPC1

CSA Certified Class I Div. 1 power connection or end termination kit for use with any wattage B, N, J or P tracer. Installs in customer supplied junction box with 1/2" npt hub.



T9355-PC

ATEX standards approved power connection kit for use with any wattage B, N, J, P, JV or JN tracer.



T210-ET

FM Approved and CSA Certified Class I Div. 2 electric tracer termination kit for use with any wattage B, N, J or P tracer.



T355-ET

ATEX standards approved electric tracer termination kit for use with any wattage B, N, J, P, JV, or JN tracer.

Installation Tools

TRACEPAK is designed to be installed using standard bending tools. We have designed two special tools that make installation of TRACEPAK tube bundles easier and more compact.

Bundle Bending Tool

Similar to a common electrical conduit bender, this tool is compact and easy to use. It eliminates the need for larger and heavier benders that have the required 8" (200mm) minimum bending radius.



2 1/8" (54mm) Centerline Tool

A replacement for the standard tube bender, it brings the process tubes to the correct centerline for connecting to typical transmitters. This tool makes back-to-back bends easier accomplishing the bends in a much shorter distance than possible with a standard tube bender.

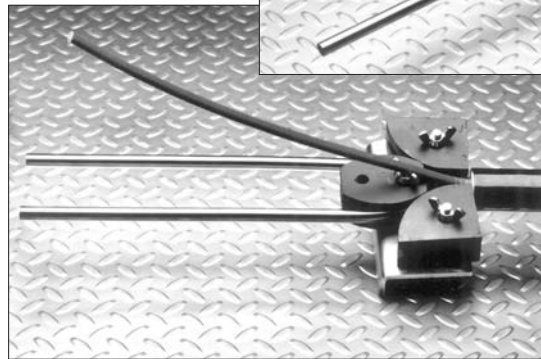
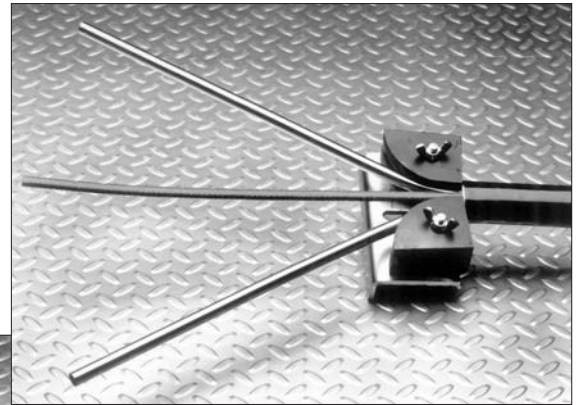
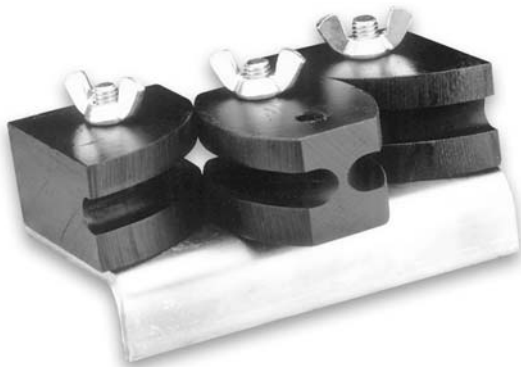

Installation DVD

Helpful information on the installation of TRACEPAK tubing bundles. The DVD deals with general installation procedures and gives a good overview of the products and accessories available to complement and complete the total package.



O'BRIEN CORPORATION
 1900 Crystal Industrial Court
 St. Louis, MO 63114
 Phone (314) 236-2020 FAX (314) 236-2080
 Email obcorp@obcorp.com

TRACEPAK® DESIGN REQUEST

Required By: _____

From

Rep

Date

End User

Notes:

SITE CONDITIONS

Outdoor Indoor Low Ambient _____°F/C High Ambient _____°F/C Wind 25mph

HEATING CONDITIONS

Desired Maintenance Temperature _____°F/C

Minimum Maintain _____°F/C Maximum Maintain _____°F/C

If an Analyzer Line what is the inlet temperature of gas? _____°F/C

PROCESS TUBING

Quantity _____ft. Are Exact Cut Lengths Required? _____ft.

Number of Process Tubes _____

O.D. of #1 Process Tube _____in. Welded or Seamless?

Wall Thickness _____in. Material of Construction _____

O.D. of #2 Process Tube _____in. Welded or Seamless?

Wall Thickness _____in. Material of Construction _____

IF ELECTRIC TRACING

Electrical Voltage _____VAC Area Classification _____ Division _____

Will Steam be used to blow down this bundle? _____ What Temperature or bar _____°F/C

IF STEAM TRACING

Steam Pressure _____psig Temperature _____°F/C

Maximum Blow Down Temperature _____°F/C

O.D. Tracer Tube _____in. Welded or Seamless?

Wall Thickness _____in. Material of Construction _____

ACCESSORIES

Heat Shrink Boots

Entry Fittings

SensorTube™

Thermostats

Power Kits

RTD / PT100 Kits

Termination Kits

Splice Kits

Controllers

Jacket Patch Kits

Silicone End Sealant

Installation DVD

OTHER TRACING LIQUIDS - Flow must be turbulent

Flow Rate _____lbs/hr

Specific Heat _____Btu/lb°F

Minimum Inlet Temperature (for heating) _____°F/C

Maximum Inlet Temperature (for cooling) _____°F/C

Density _____lb/ft³ Viscosity _____centipoise

HEAT EXCHANGER APPLICATIONS - Flow must be turbulent

LIQUID OR GAS

Flow Rate _____lb/hr Temperature at inlet _____°F/C

Desired Temperature at Outlet _____°F/C Density _____lb/ft³

Maximum allowable outlet temp _____°F/C Viscosity _____centipoise

Minimum allowable outlet temp _____°F/C Specific Heat _____Btu/hr°F

Thermal Conductivity _____Btu.hr ft²°F

(O'Brien will determine minimum length for heat exchanger applications)

NOTES:

MATERIAL SPECIFICATIONS

The following specifications apply to all members of the TRACEPAK family.

JACKET	TUBING				TEMPERATURE LIMITS
Thermoplastic Polyether Urethane Elastomer			CONSTRUCTION AND		Minimum installation temperature -40°F (-40°C)
	OD	WALL	MATERIAL	ASTM	
Hydrolytically Stabilized	1/4"	0.035	welded 316SS	A-269	Maximum jacket surface temperature
Halogen Free	3/8"	0.035	welded 316SS	A-269	140°F (60°C) at ambient temperature of
	1/2"	0.035	welded 316SS	A-269	80°F (27°C) with maximum process or
Abrasion Resistance	1/2"	0.049	welded 316SS	A-269	tracer tube temperature.
	1/8"	0.035	seamless 316SS	A-269	
UV Resistant	1/4"	0.035	seamless 316SS	A-269	
	3/8"	0.035	seamless 316SS	A-269	TPH, TPL and S-LINE
Low Temperature Flexibility	1/2"	0.035	seamless 316SS	A-269	Maximum process tube temperature 400°F (204°C)*
	1/4"	0.049	seamless 316SS	A-269	TPE
	3/8"	0.049	seamless 316SS	A-269	Continuous exposure power on.
INSULATION	1/2"	0.049	seamless 316SS	A-269	High Temperature Tracer 250°F (120°C)*
Fibrous Glass	3/4"	0.049	seamless 316SS	A-269	Low Temperature Tracer 150°F (65°C)*
	1/4"	0.030	copper	B-68, B-75	
Water Soluble Chlorides less than 100 ppm.	3/8"	0.032	copper	B-68, B-75	Intermittent exposure power on or off.
	1/2"	0.035	copper	B-68, B-75	High Temperature Tracer 420°F (215°C)*
Non-hygroscopic	1/2"	0.049	copper	B-68, B-75	Low Temperature Tracer 185°F (85°C)*
	3/4"	0.049	copper	B-68, B-75	
	1/4"	0.030	PFA Teflon®	-	Maximum tracer temperature
	3/8"	0.030	PFA Teflon	-	High Temperature Tracer T-rating T3, 392°F (200°C) except 20 w/ft T2 446°F (230°C)
	1/2"	0.062	PFA Teflon	-	Low Temperature Tracer T-rating T6, 185°F (85°C)
	1/4"	0.035	smls Monel 400	B-163,B-165	
	3/8"	0.035	smls Monel 400	B-163,B-165	
	1/2"	0.049	smls Monel 400	B-163,B-165	
	6mm	1mm	seamless 316SS	A-269	
	8mm	1mm	seamless 316SS	A-269	
	10mm	1mm	seamless 316SS	A-269	
	12mm	1mm	seamless 316SS	A-269	
	10mm	1.5mm	seamless 316SS	A-269	
	12mm	1.5mm	seamless 316SS	A-269	
	6mm	1mm	copper	B-68, B-75	
	8mm	1mm	copper	B-68, B-75	
	10mm	1mm	copper	B-68, B-75	
	12mm	1mm	copper	B-68, B-75	
	6mm	1mm	PFA Teflon	-	
	8mm	1mm	PFA Teflon	-	
	10mm	1mm	PFA Teflon	-	
	12mm	1mm	PFA Teflon	-	

*Consult factory for higher temperature limits.

Tubing meeting NACE MR-01-75-90 and ASTM A-213-EAW specifications are also stocked. Consult factory for the availability of these as well as other materials and specifications.

Integrated Solutions Improving Process Accuracy
TRACEPAK VIPAK HEATPAK SADDLEPAK FLEXPAK



Customer Service

Customer service takes on a whole new meaning at O'Brien Corporation. Our reputation as a customer-oriented problem solver has been long recognized.

O'Brien's customer-oriented approach offers these benefits:

- responsive, knowledgeable personnel
- unparalleled delivery service
- dependable, tested results of all product lines
- in-house stock of hard -to-find materials

Unparalleled 9001 Quality System

Certified to current ISO 9001 standards. Our adherence to recognized international quality standards provides one of the strongest assurances of product and service quality available.

Total Solution

From Instrument to Process Line: Working together, we can develop installation details. Our total engineering package will reduce field installation costs and provide a dependable solution for your needs.



ISO 9001:2000



Worldwide Offices:

1900 Crystal Industrial Ct. • St. Louis, MO 63114 • Ph 314/236-2020 • Fax 314/236-2080
Mallekotstraat 65 • B 2500 Lier Belgium • Ph (+32) 3 491 9875 • Fax (+32) 3 491 9876
Suite 400 • 609 14th Street NW • Calgary, AB T2N 2A1 • Ph 403/730-7277 • Fax 403/730-7279
obcorp@obcorp.com • www.obrien-analytical.com